

PARMA

20 min.

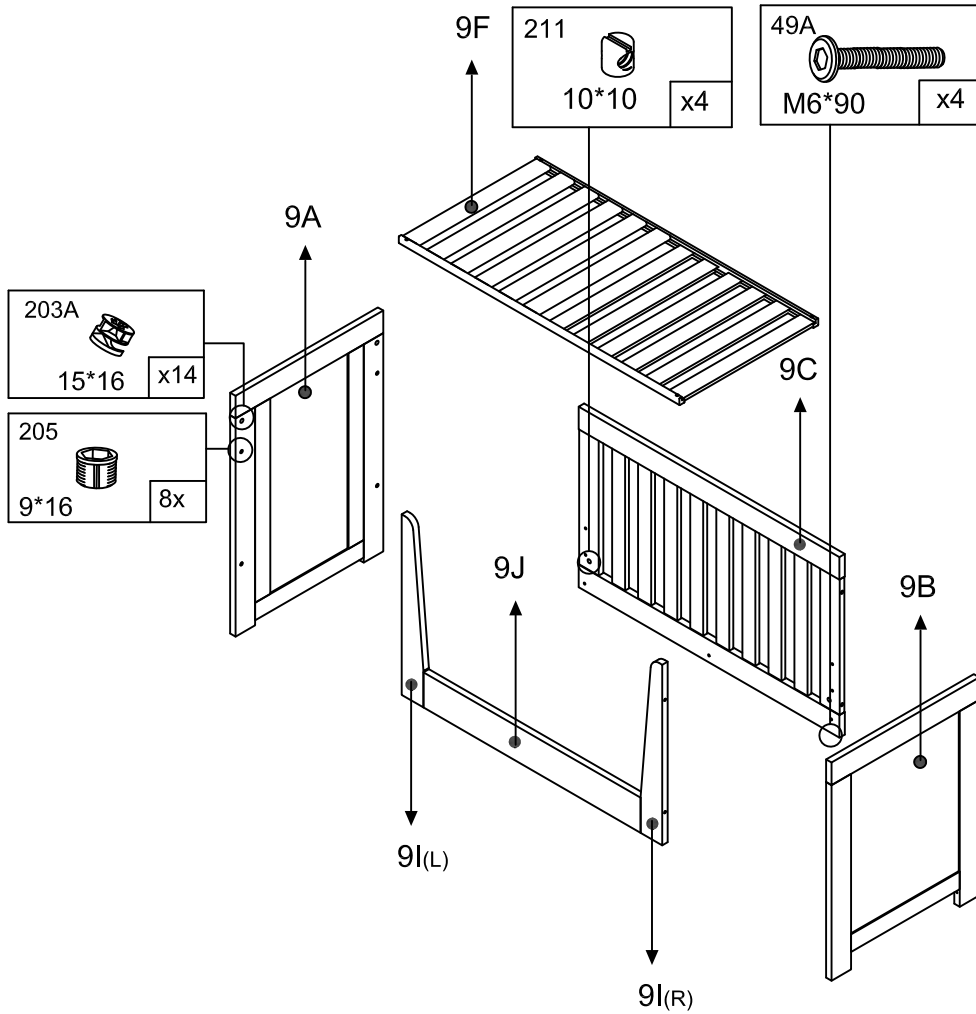
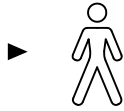

PAR9412: 9P,9I,9J

9P

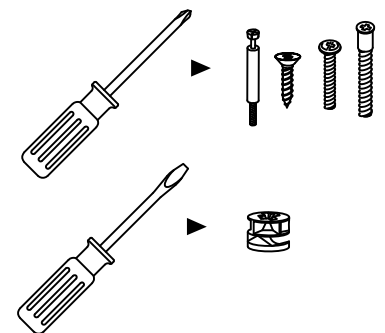
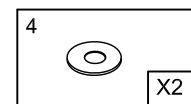
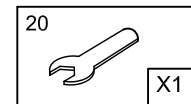
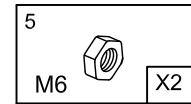
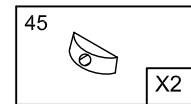
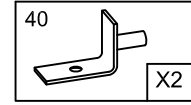
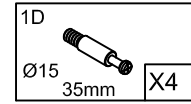
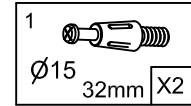
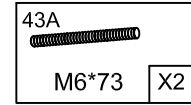

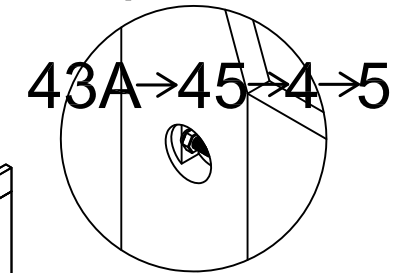
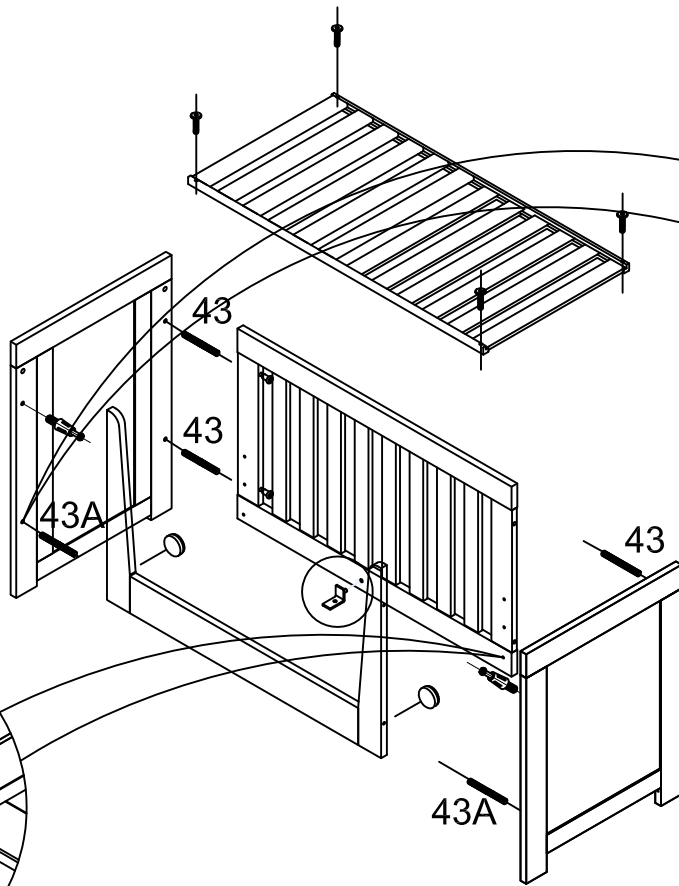
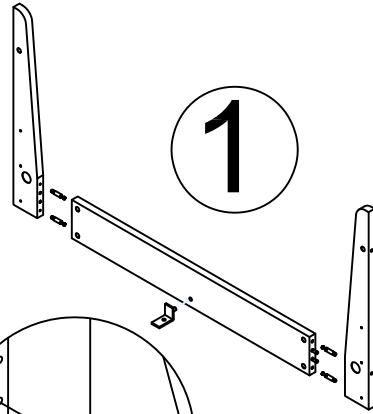
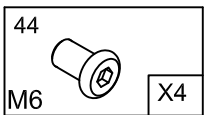
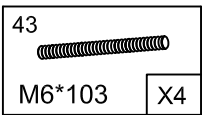
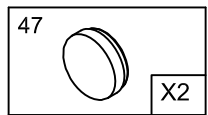
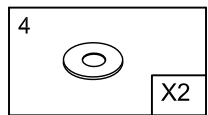
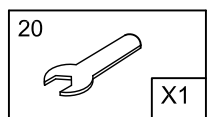
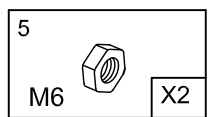
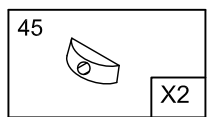
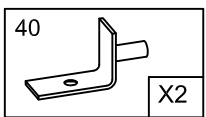
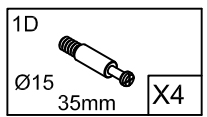
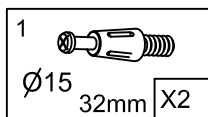
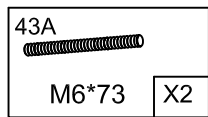

1

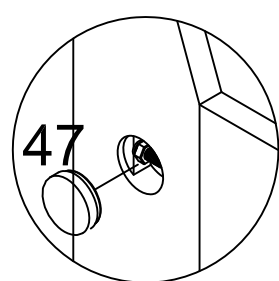

2



3

