

KINGSTON

KIN3101: W1,W2,W3,3L
 KIN3201: 3A,W4,3E,3K,3J
 KIN3301: W6,W7
 KIN3401: 3D

70 min. ▶

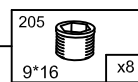
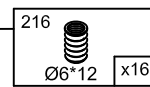
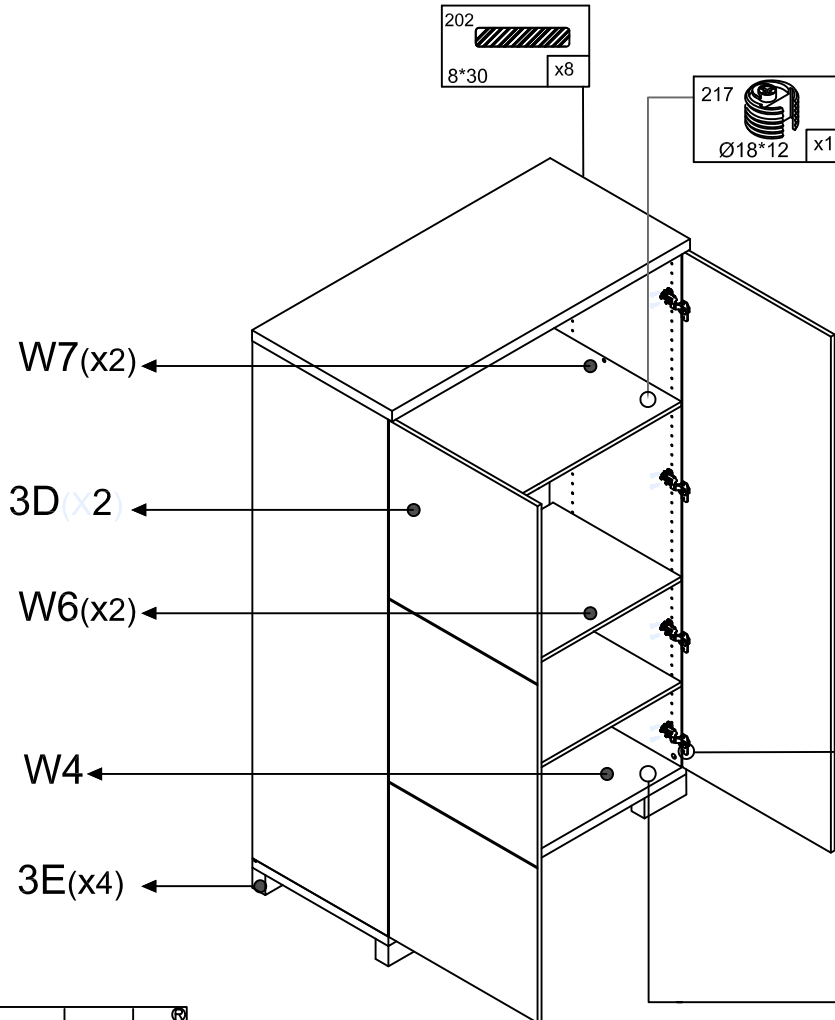
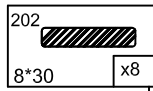
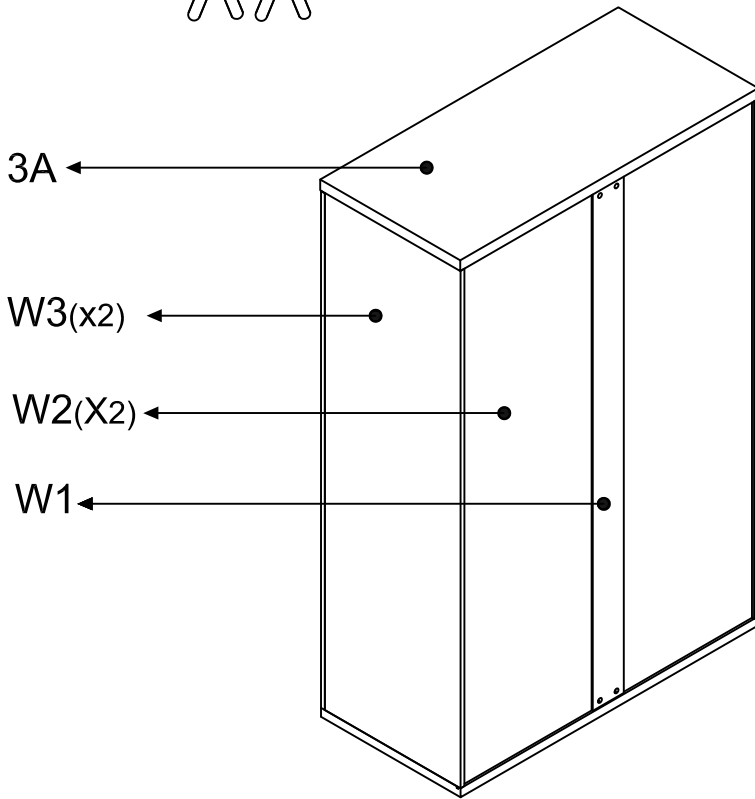
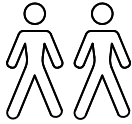

3K

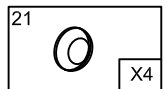
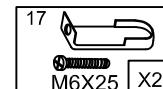
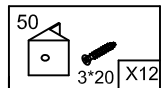
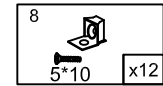
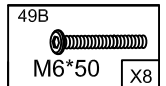
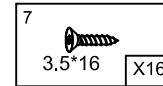
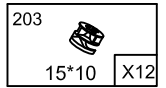
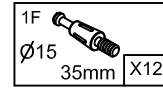

3L

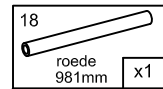

3J

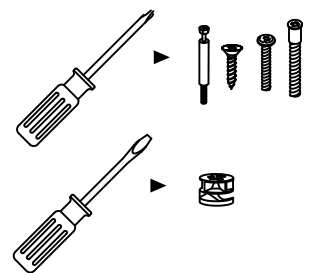
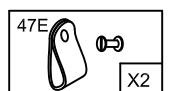
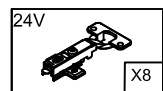

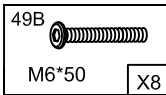

3E
W4

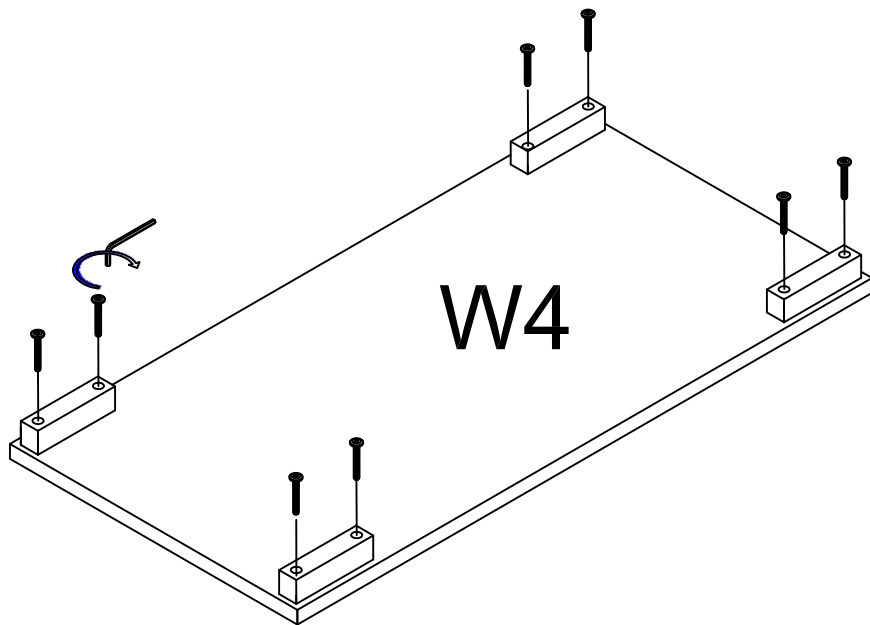

1

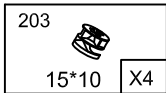
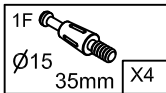

W3(X2)

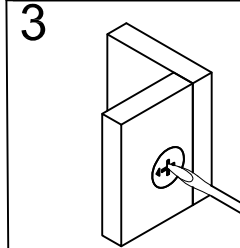
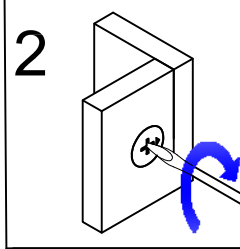
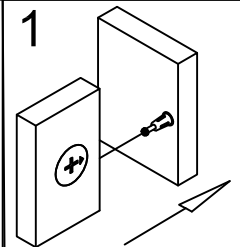
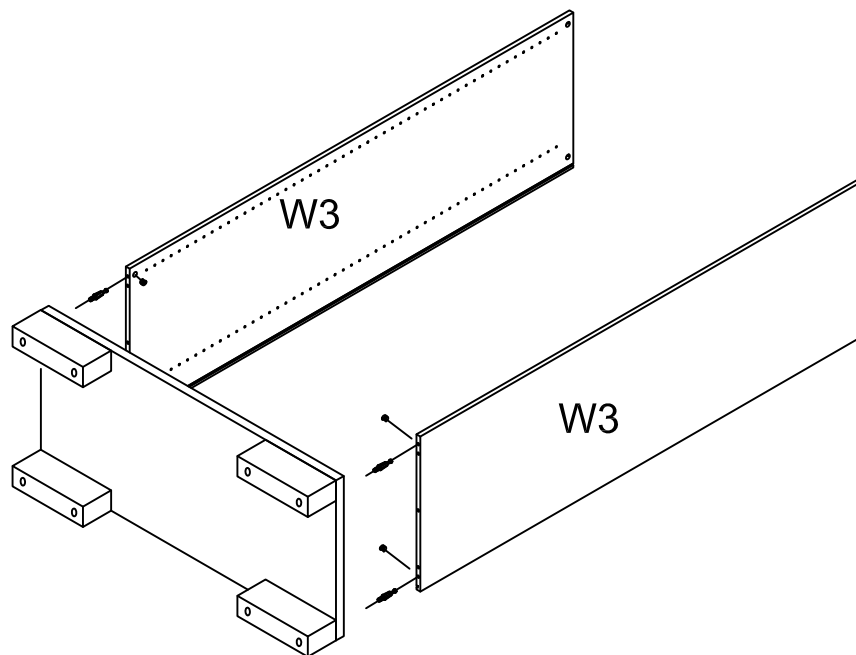

2

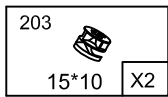
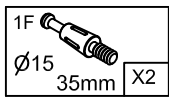

W1
W2(x2)

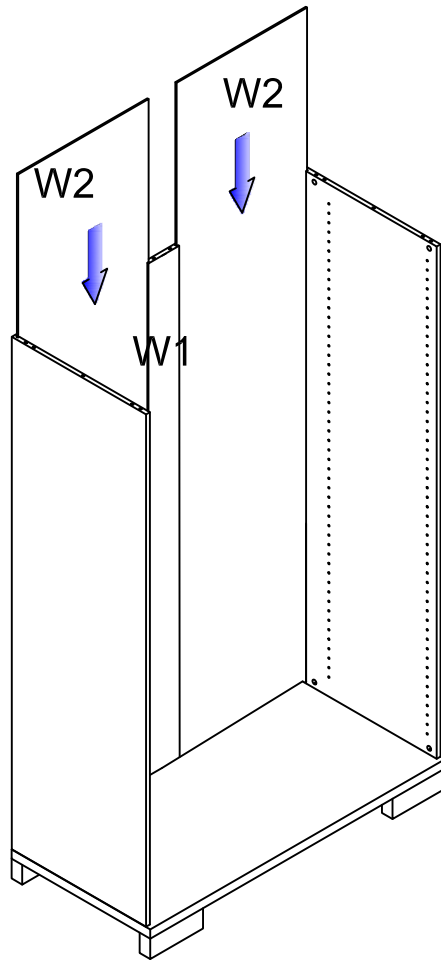

3

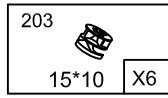
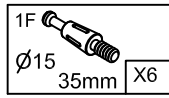

3A

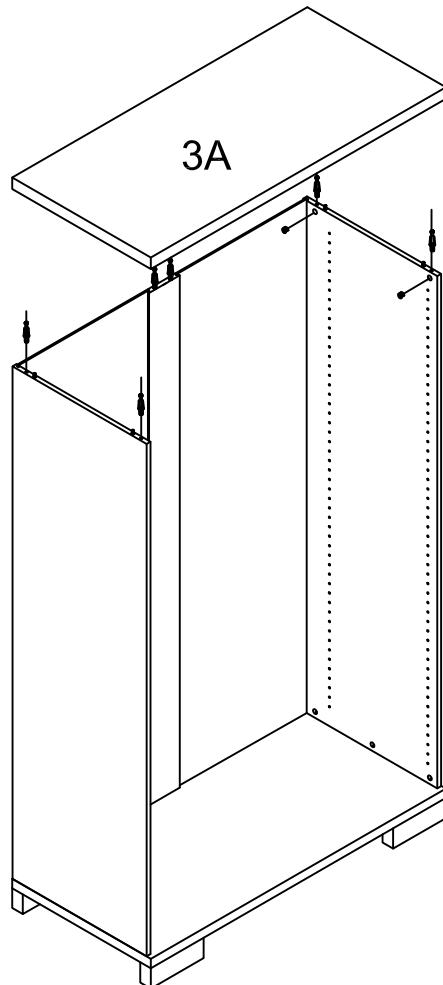

4

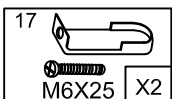
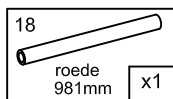
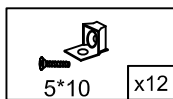

W7
W6(x2)

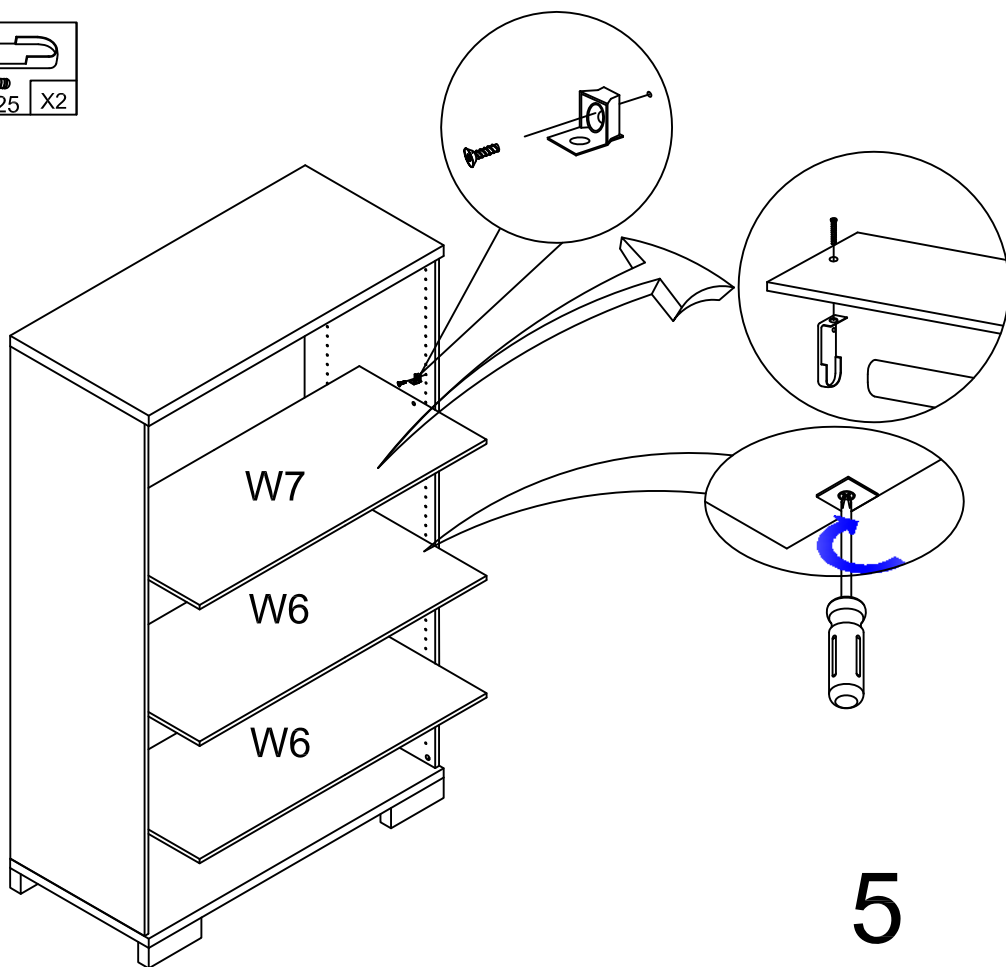

5

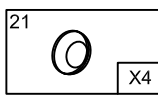
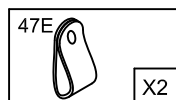
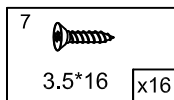
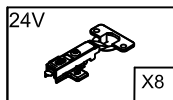

3D

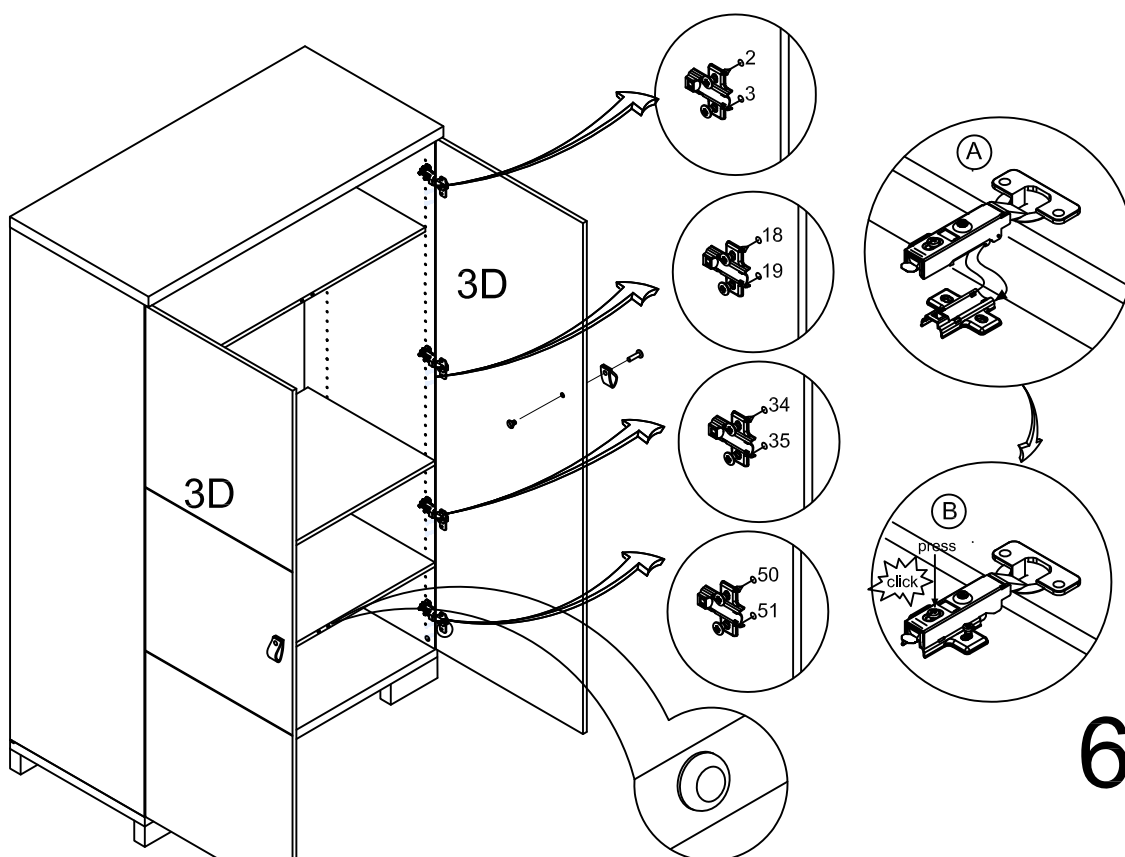

6

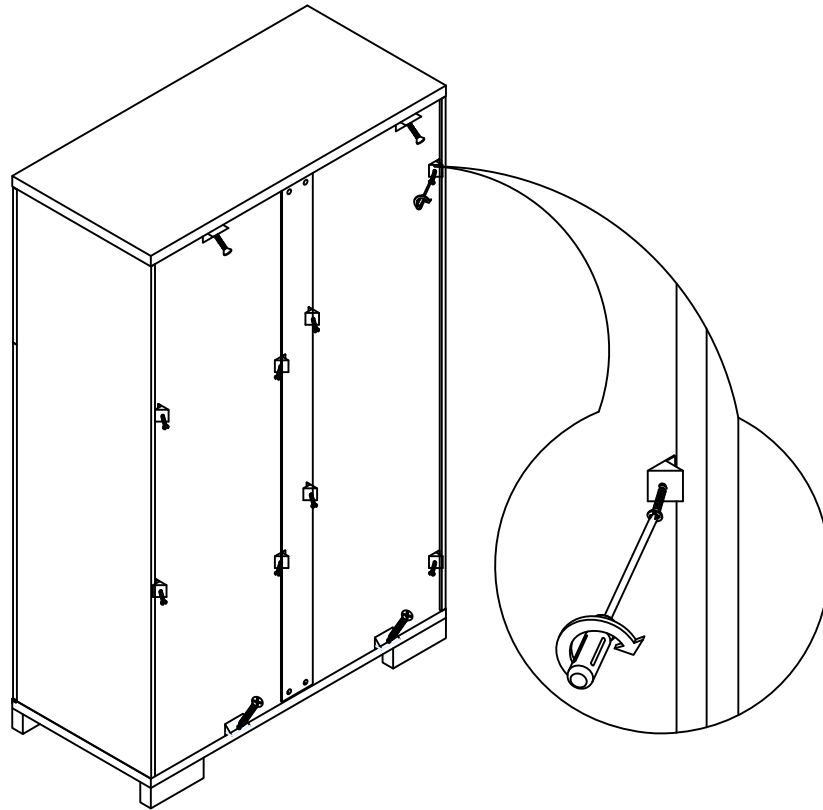
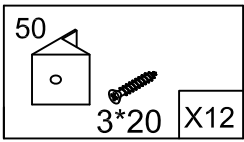

7

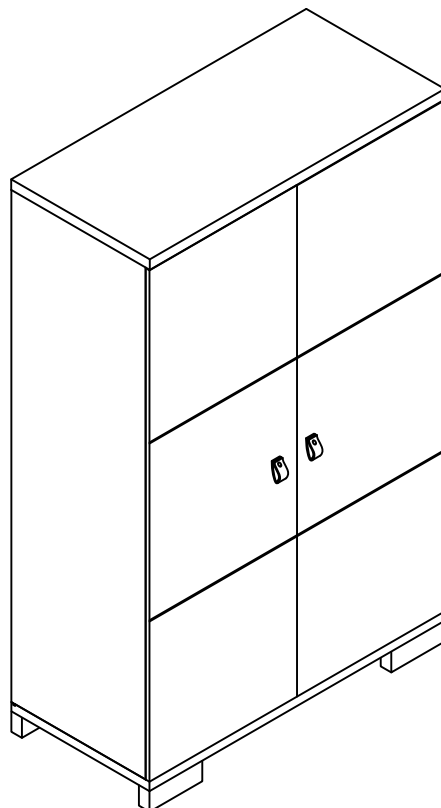

8

Deuren stellen:

- Stap A: kast waterpas plaatsen
- Stap B: deuren vlak stellen
- Stap C: deuren op hoogte stellen
- Stap D: deuren op breedte stellen

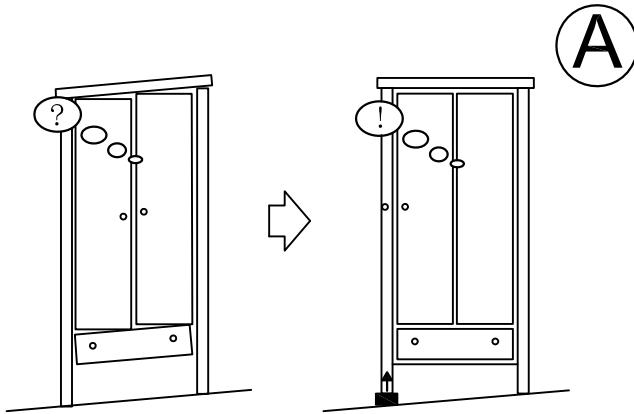

Plaats een wig of een op gewenste dikte gevouwen vel papier indien 1 van de poten vrij van de vloer komt of indien de kast niet haaks staat

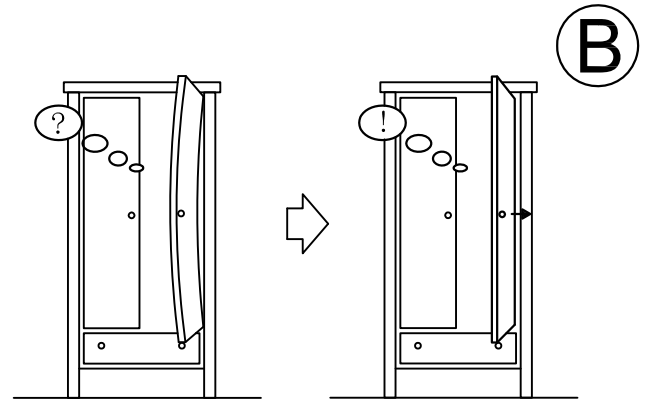

Deur m.b.v. middenscharnier op diepte stellen

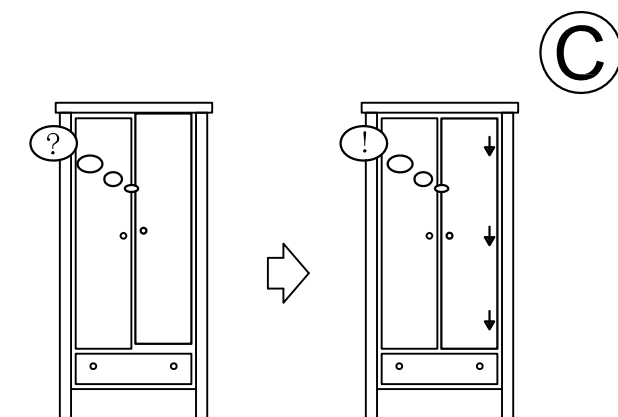
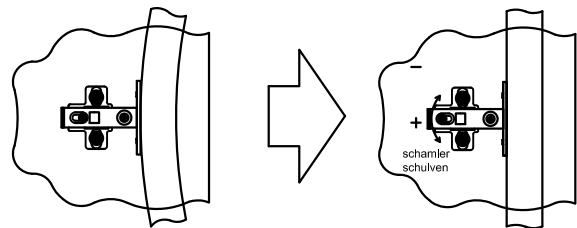

Scharnieren stellen in hoogte

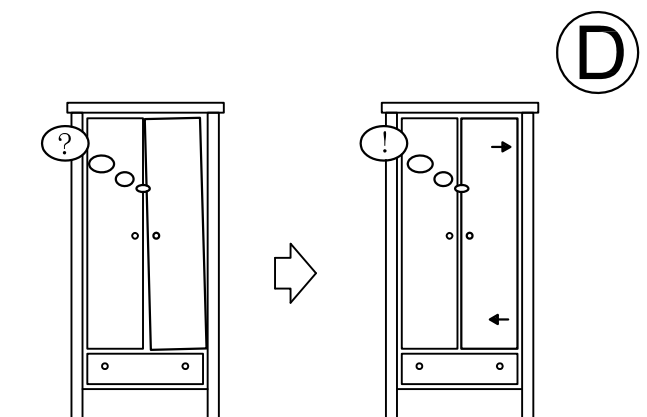
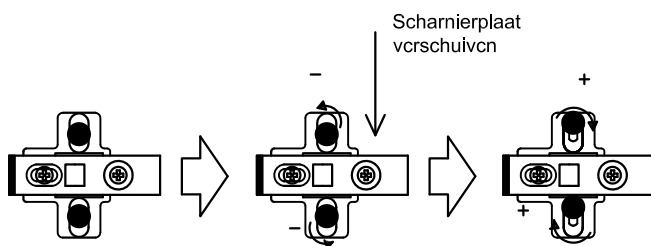

Deur naar links/rechts stellen

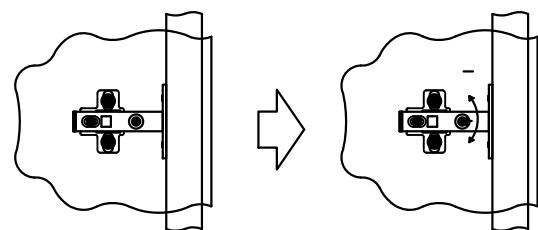

+ = meer ruimte
- = minder ruimte

Veiligheidsbanden / Safety belts / Sicherheitsbande / Cordons de sûreté / Cintas de seguridad.

NL

Dit product is uitvoerig getest op sterkte, stevigheid en stabiliteit. Zorg er desondanks voor dat u er waakzaam op bent dat uw kind niet gaat klimmen en klauteren op of gaat hangen aan het meubel. In het bijzonder bij geopende lades en deuren kan dit tot gevaarlijke omstandigheden leiden. Om de veiligheid van uw kind zoveel mogelijk te kunnen garanderen dient u de bijgeleverde veiligheidsbanden volgens de handleiding te monteren.

EN

The stability and strength of this product have been tested extensively. In spite of this take good care of your child's behaviour: the child should not be climbing into or hanging on the product. This could be dangerous, especially when the drawers and doors are opened. To guarantee the safety of your child as much as possible you have to mount the included safety belts according to assembling instructions.

DE

Die Stärke und Stabilität dieses Produktes ist umfassend getestet. Beobachten Sie daß Ihr Kind nicht klettert auf oder hängt an das Möbel. Diese Situation kann gefährlich sein wenn zum Beispiel die Schubladen oder Türe geöffnet sind. Um die Sicherheit Ihres Kindes so viel wie möglich zu garantieren, verwenden Sie die Sicherheitsbande wie beschrieben im Montageanleitung.

F

Ce produit a été testé sur solidité et stabilité. Veuillez faire attention que l'enfant ne se monte pas sur le meuble, particulièrement dans le cas que les tiroirs et les portes sont ouvertes. Pour garantir la sûreté de votre enfant, veuillez monter les cordons de sûreté selon manuel.

ES

La estabilidad y resistencia de este producto ha sido probada extensamente. A pesar de ello, no descuide el comportamiento de su niño: el niño no debe trepar ni agarrarse al producto. Esto podría ser peligroso, especialmente cuando las puertas y los cajones estén abiertos. Para garantizar la seguridad de su niño al máximo, debe fijar las cintas de seguridad incluidas, según indican las instrucciones de montaje.

1 ▷

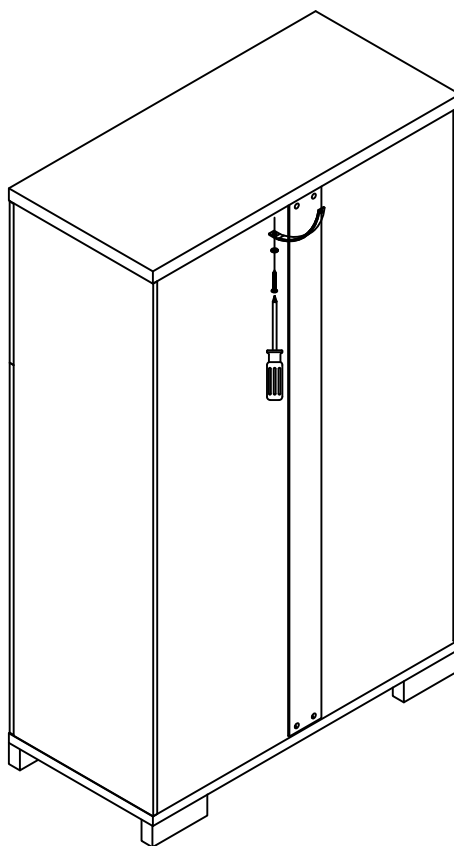
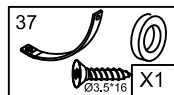

2 ▷

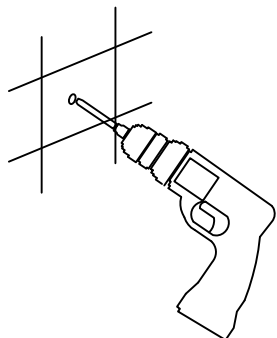

3 ▷

