

# HOUSTON

20 min.

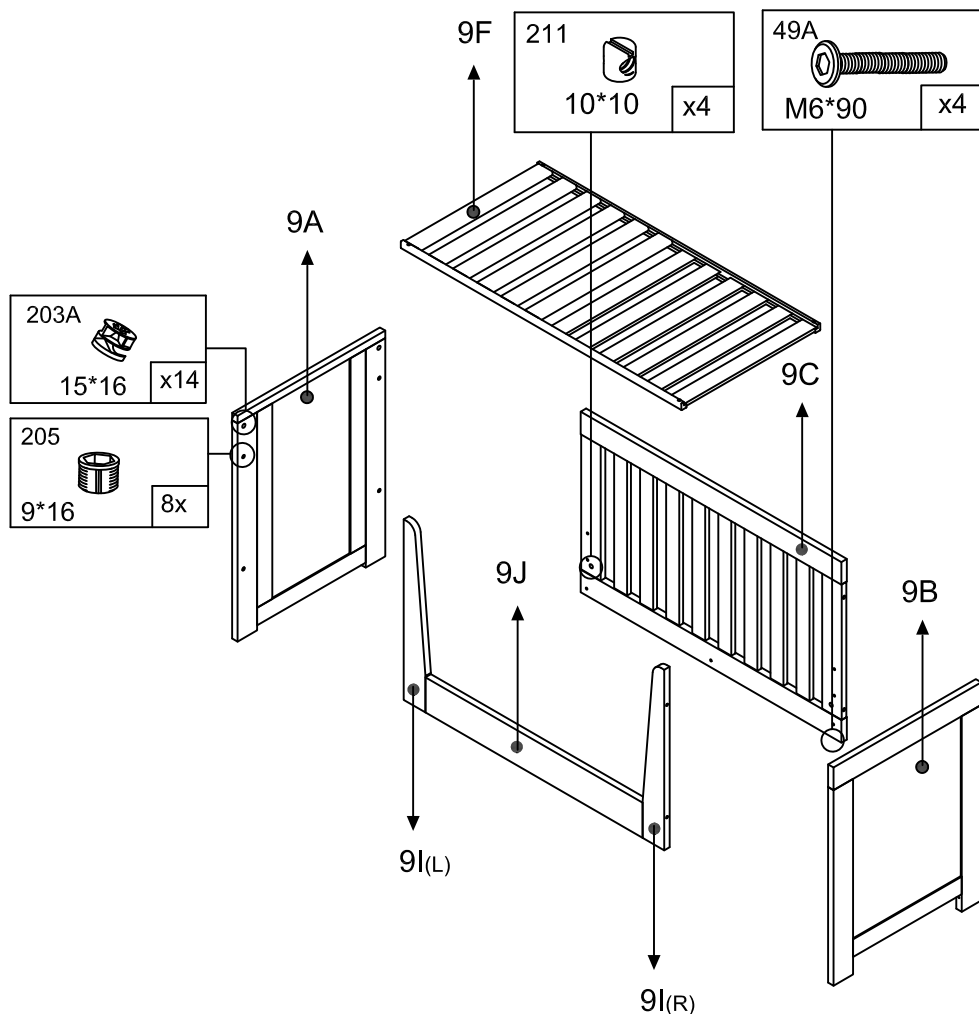
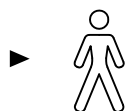

## HST9454: 9P,9I,9J

### 9P

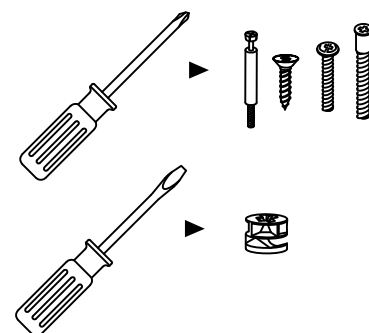
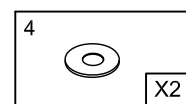
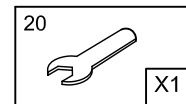
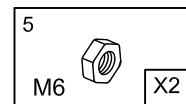
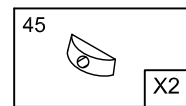
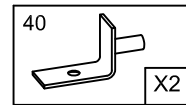
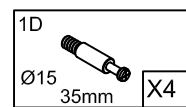
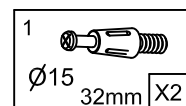
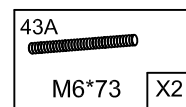

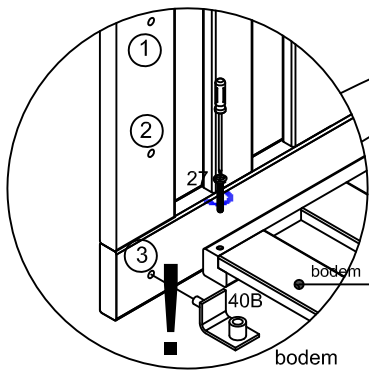
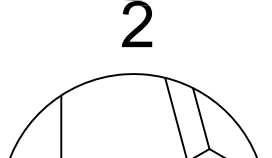
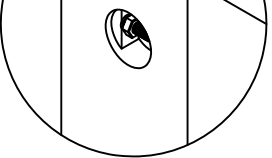
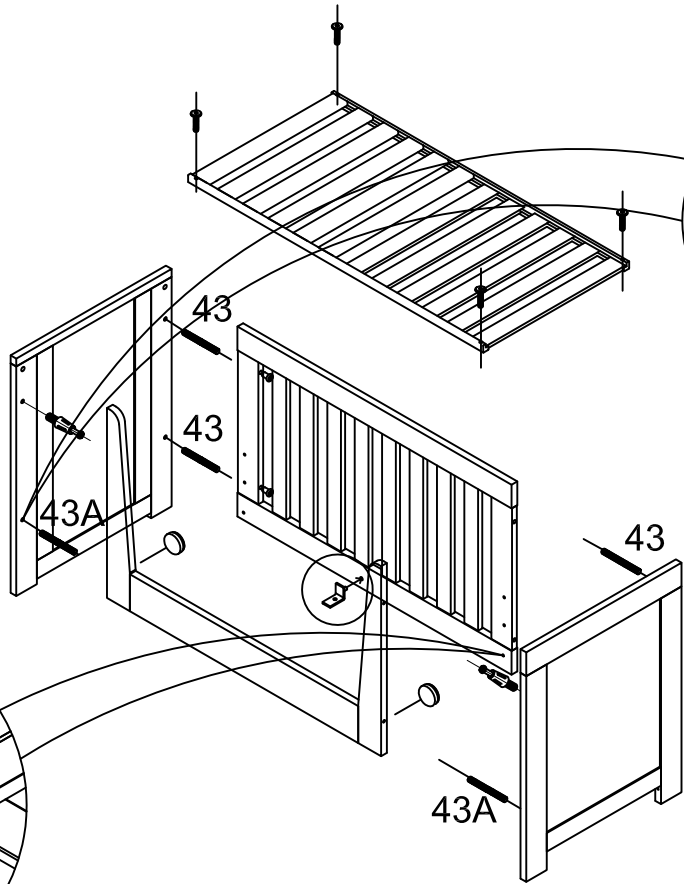
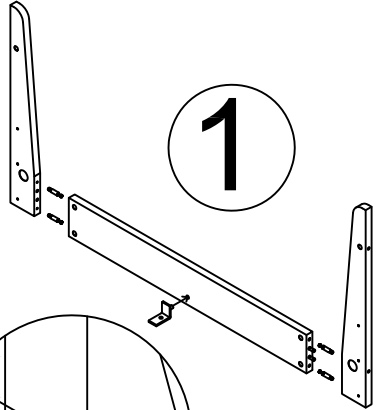
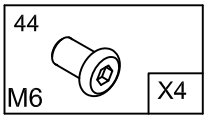
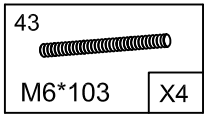
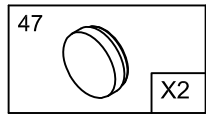
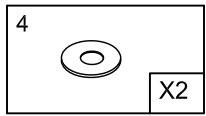
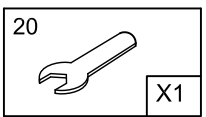
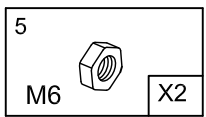
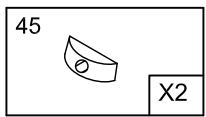
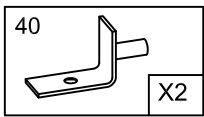
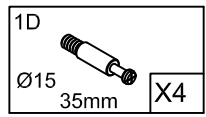
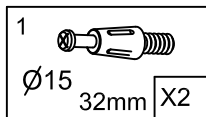
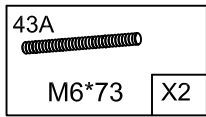

bodem vastschroeven!

