

VENUS

80 min. ▶

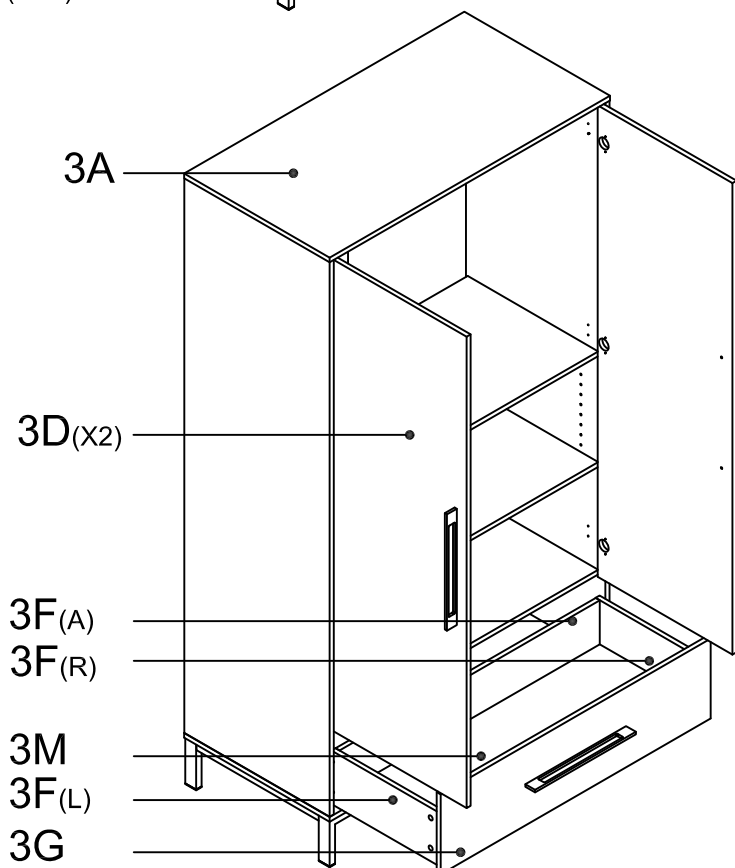
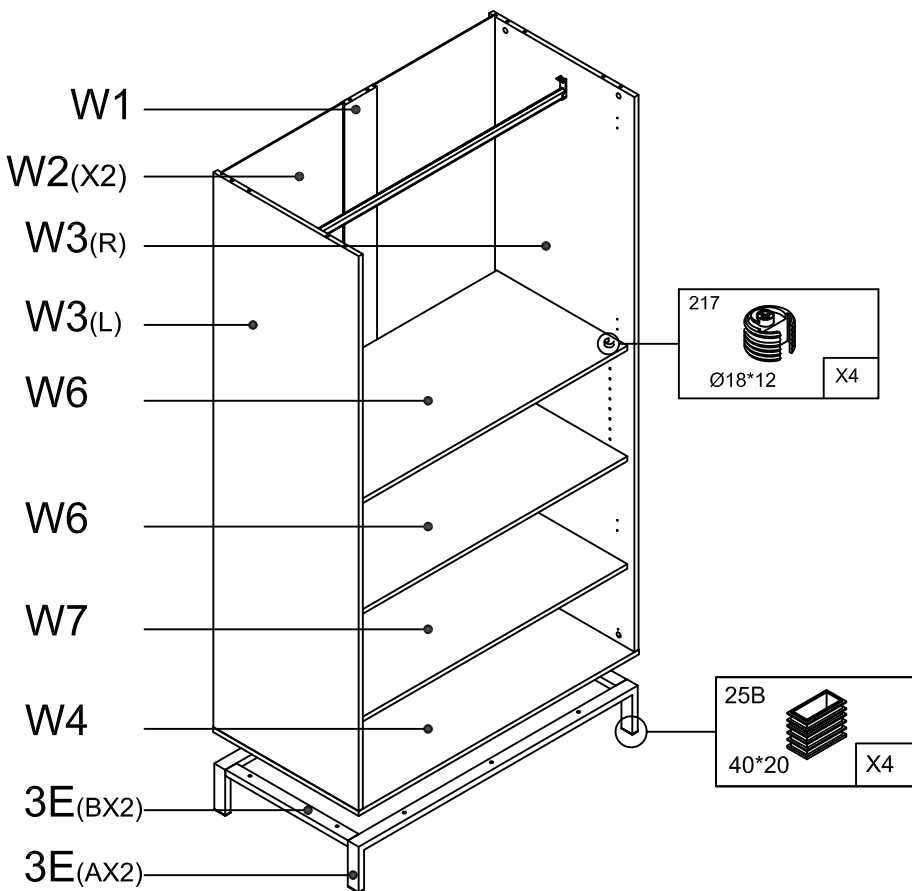
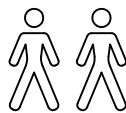

VEN3103: 3A,3L,3M,W4,W6,W7

VEN3203: W1,W2,W3

VEN3303: 3D,3G,3F

VEN3403: 3E,3K,3J

3K

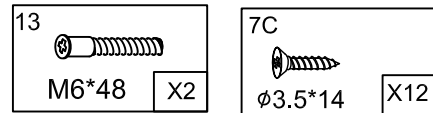
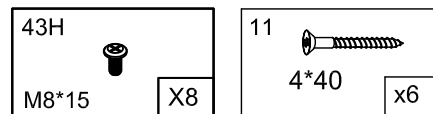
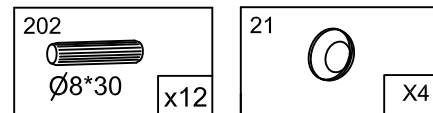
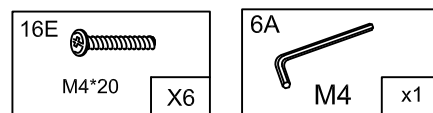
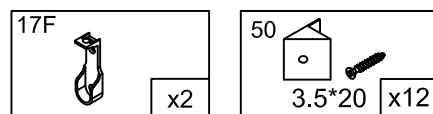
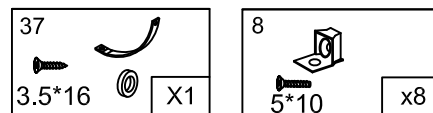
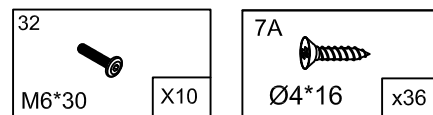
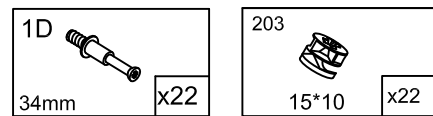

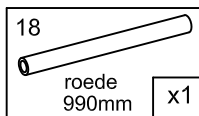

3L

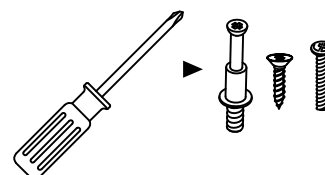
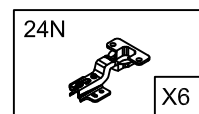
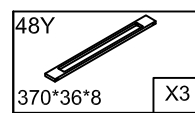
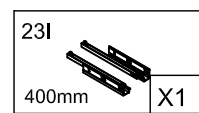

3J





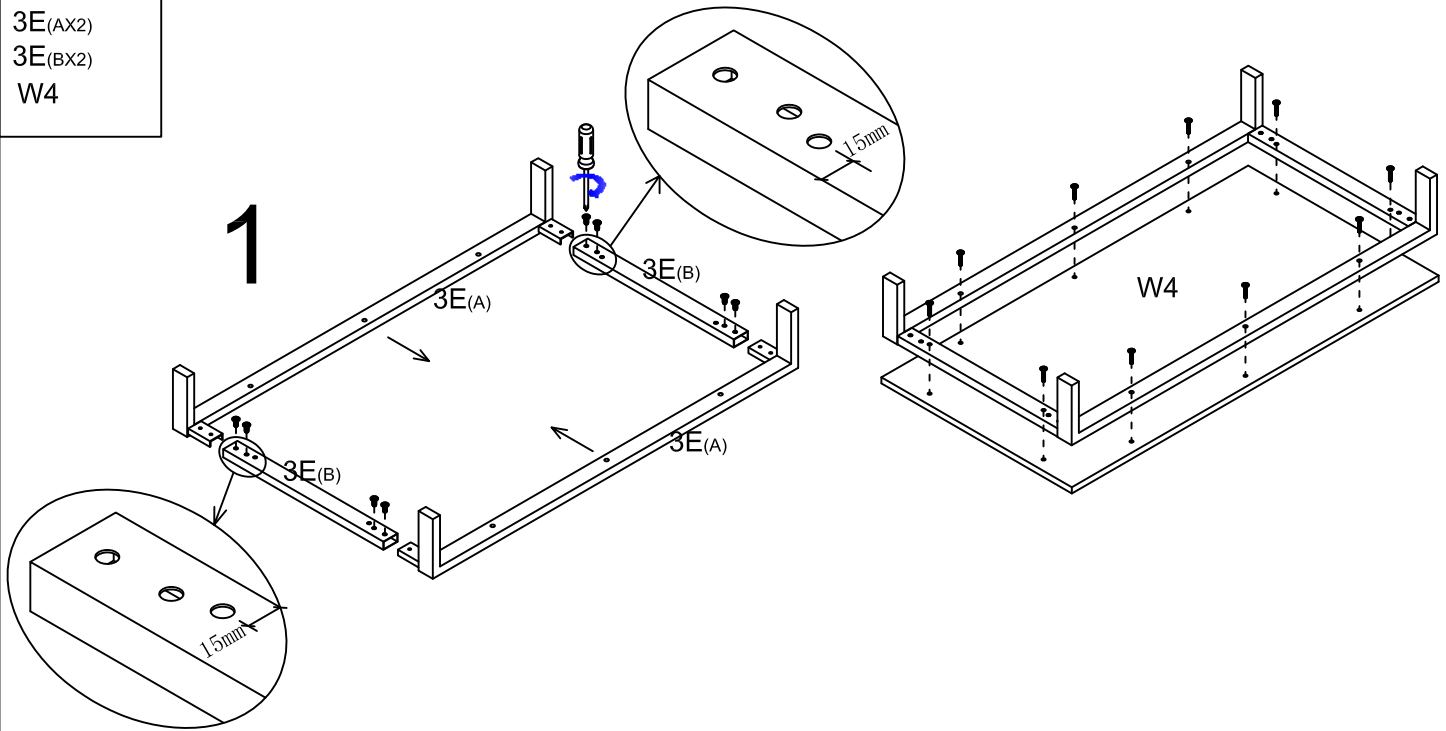

43H  M8*15	X8	32  M6*30	X10	6A  M4	x1
--	----	---	-----	--	----

3E(Ax2)
3E(Bx2)
W4

1



1D  34mm	X4	203  15*10	x4	202  Ø8*30	X4
---	----	---	----	---	----

8  5*10	x8
--	----

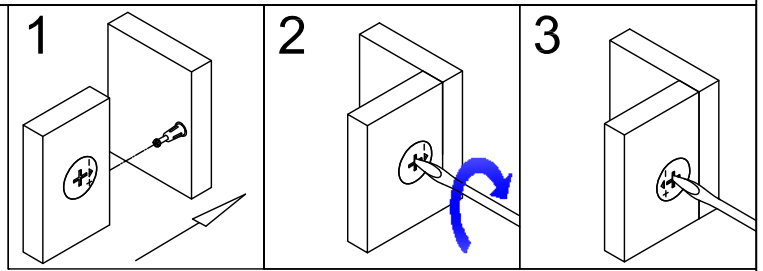

W7
W3(L)
W3(R)

2

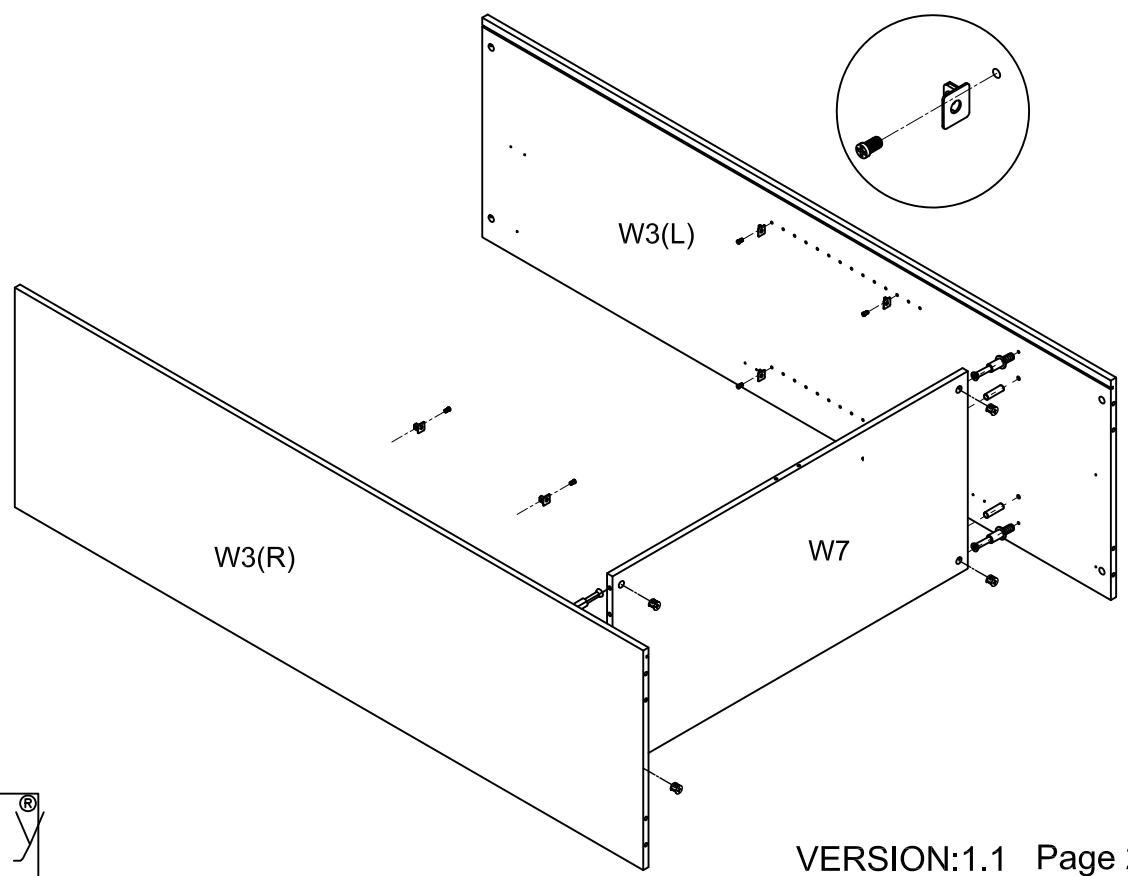

1D 34mm X4	203 15*10 x4	202 Ø8*30 X4	7C Ø3.5*14 X4	17F X2
------------------	--------------------	--------------------	---------------------	-----------

W6(x2)

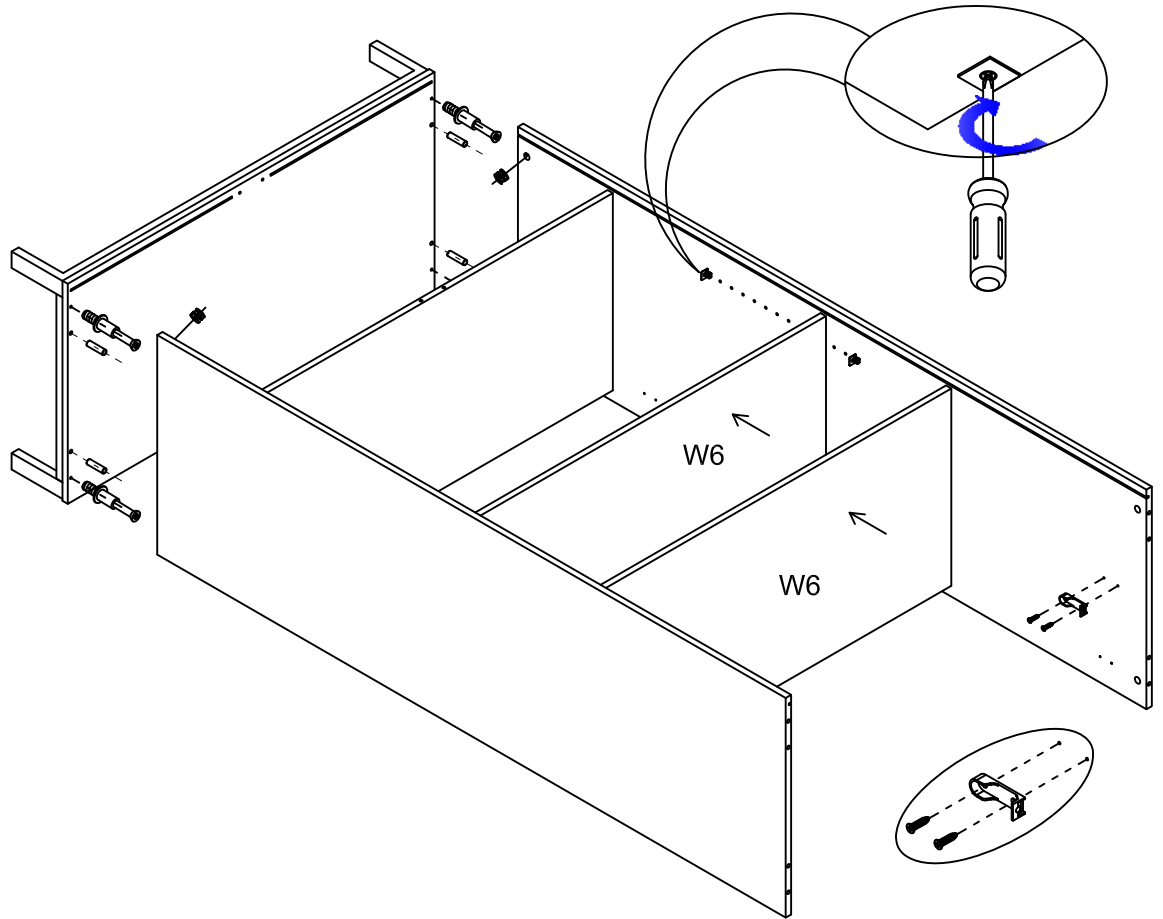

3

1D 34mm X2	203 15*10 x2
------------------	--------------------

W1
W2(x2)

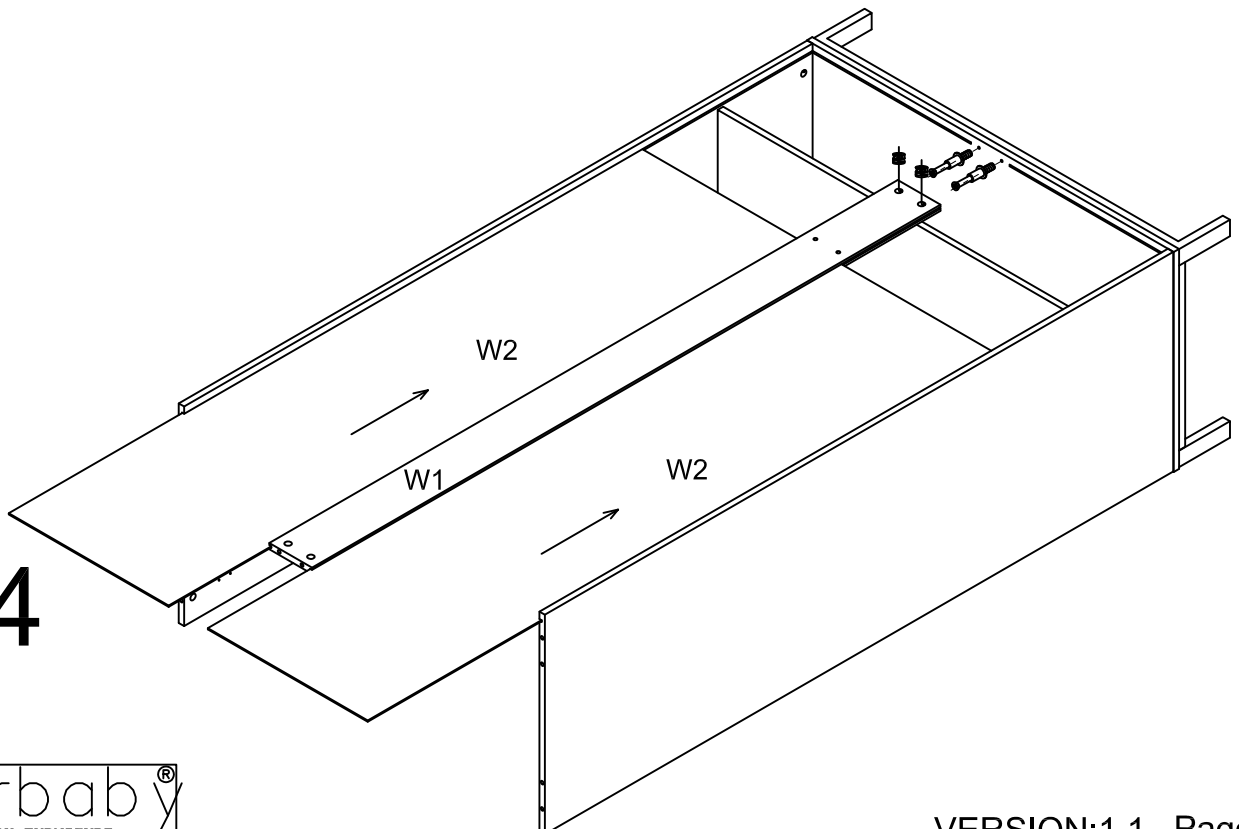

4

1D 34mm X6	203 15*10 x6	202 Ø8*30 X4	13 M6*48 X2	23I 400mm X1	7C Ø3.5*14 X8
18 roede 990mm X1	21 X4				

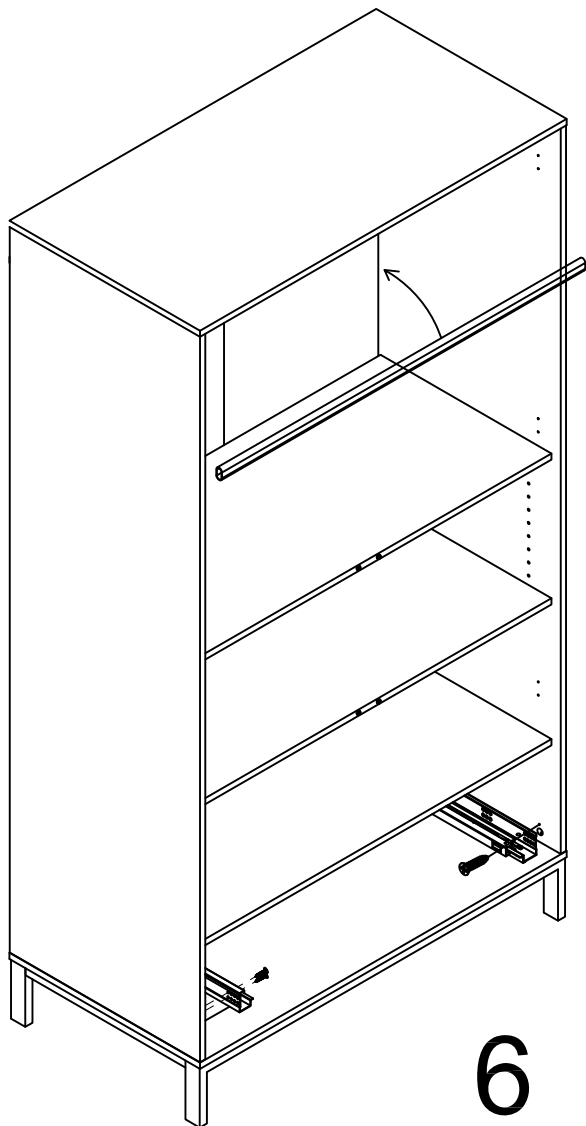
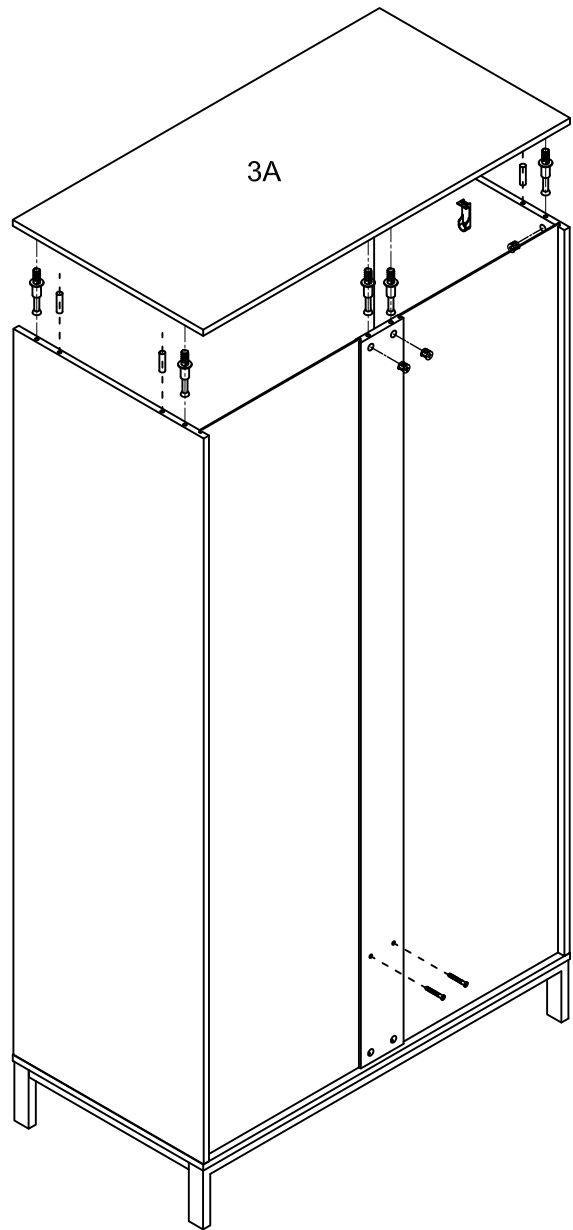

3A

5

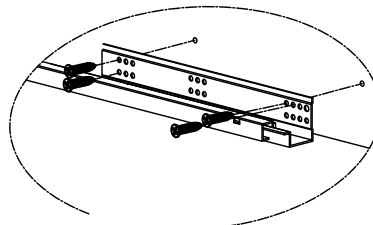
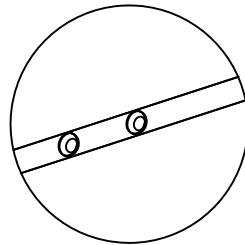

6

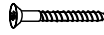
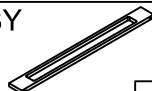

16E  M4*20	X2	1D  34mm	X6	203  15*10	X6	11  4*40	X6	48Y  370*36*8	X1
---	----	---	----	---	----	---	----	---	----

- 3F(A)
- 3F(L)
- 3F(R)
- 3F(O)
- 3G
- 3M

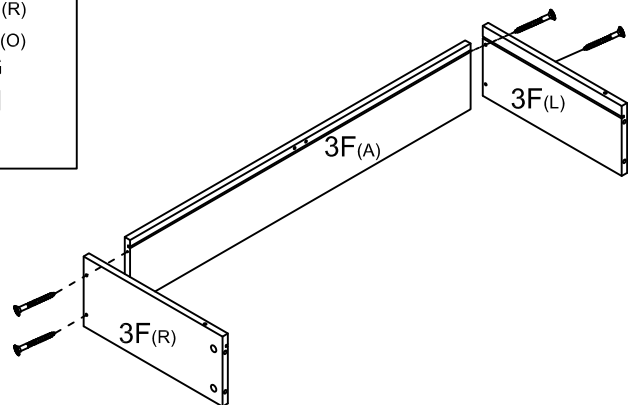

7

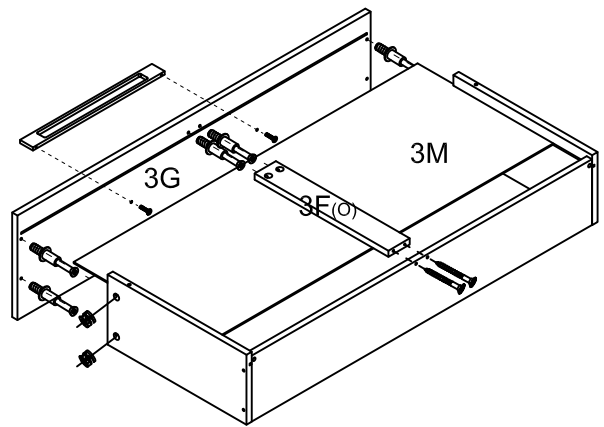

8

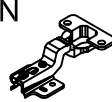

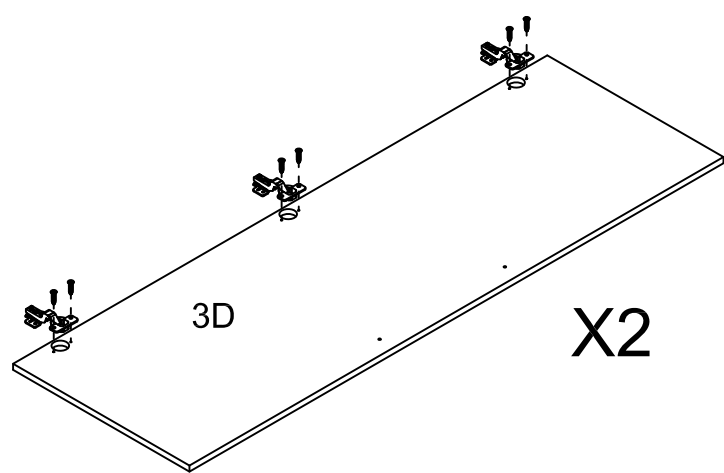

7A  Ø4*16	X12	24N  X6
--	-----	--

- 3D(x2)

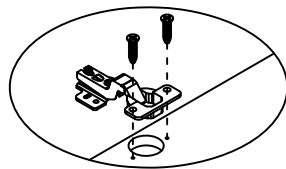

9



16E  M4*20	X4	48Y  370*36*8	X2	7A  ø4*16	X12	50  3*20	x12
---	----	---	----	--	-----	--	-----

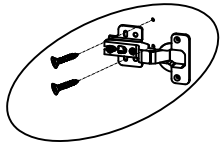
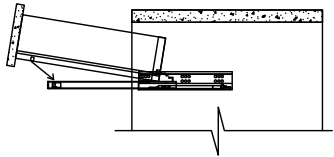

10

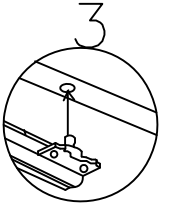
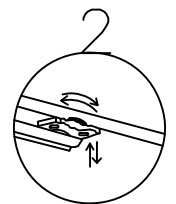
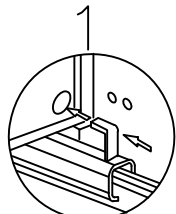
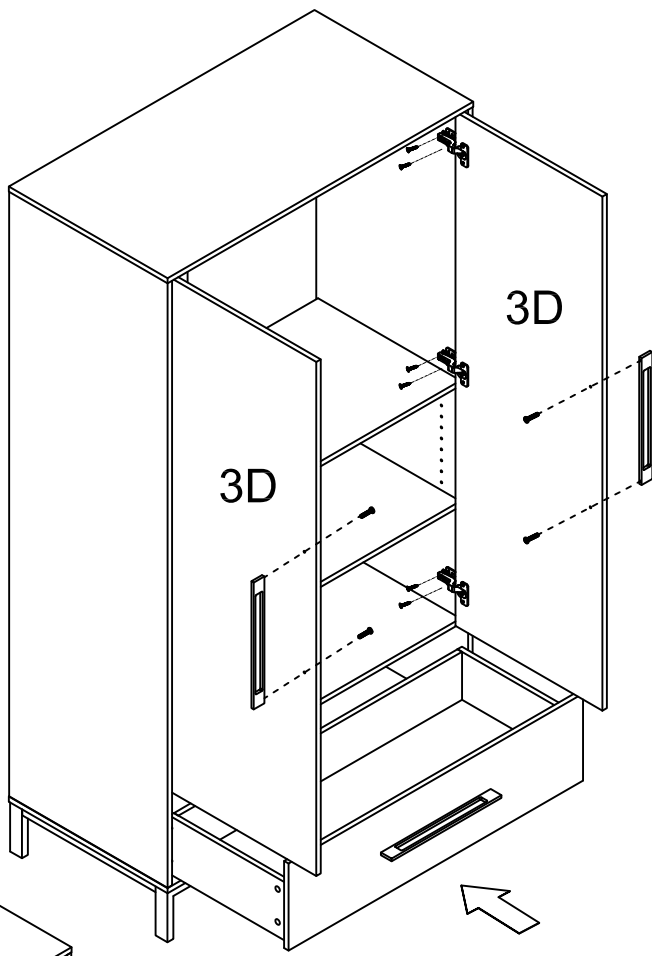

11

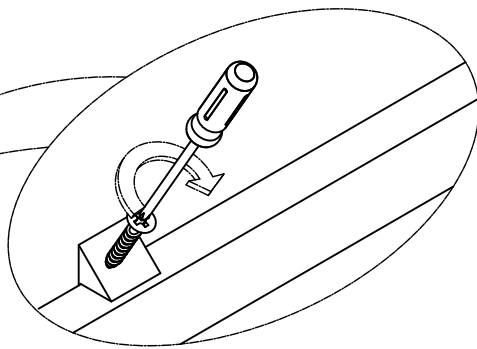
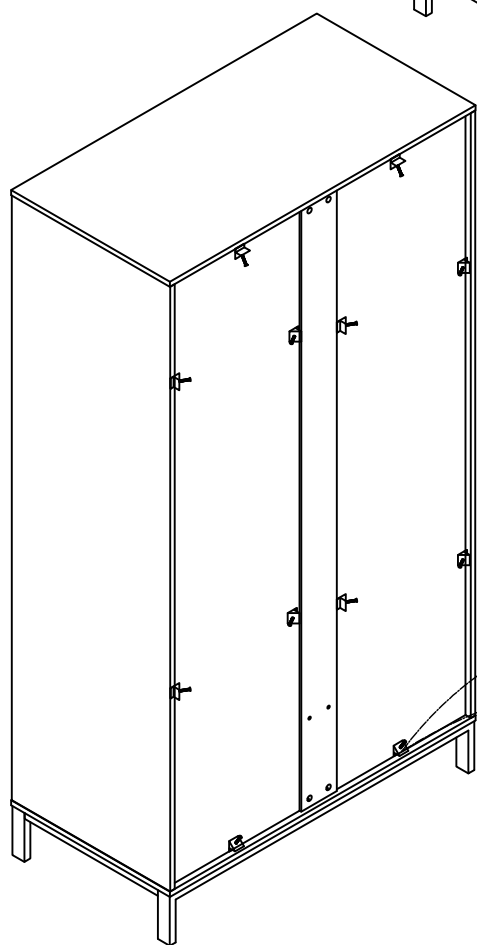

Deuren stellen:

- Stap A: kast waterpas plaatsen
- Stap B: deuren vlak stellen
- Stap C: deuren op hoogte stellen
- Stap D: deuren op breedte stellen

A

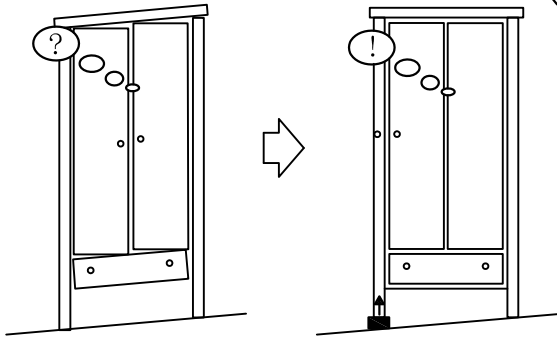

Plaats een wig of een op gewenste dikte gevouwen vel papier indien 1 van de poten vrij van de vloer komt of indien de kast niet haaks staat

B

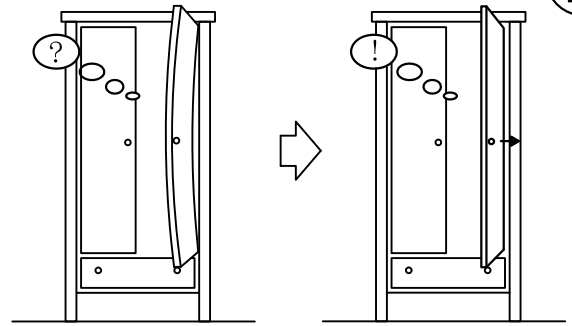

Deur m.b.v. middenscharnier op diepte stellen

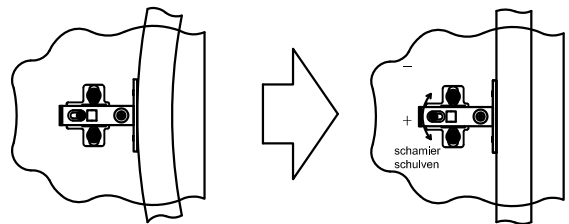

C

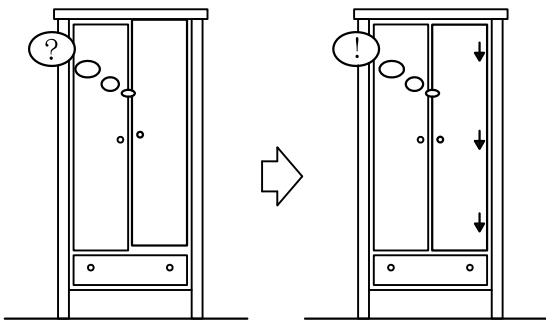

Scharnieren stellen in hoogte

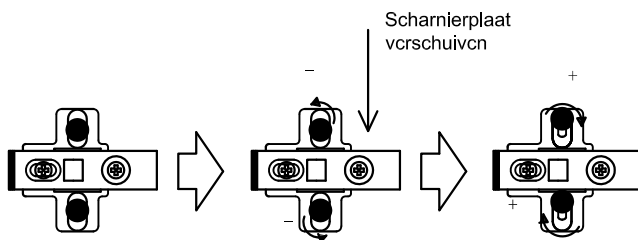

D

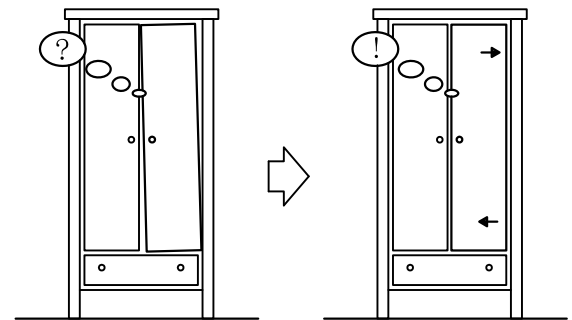

Deur naar links/rechts stellen

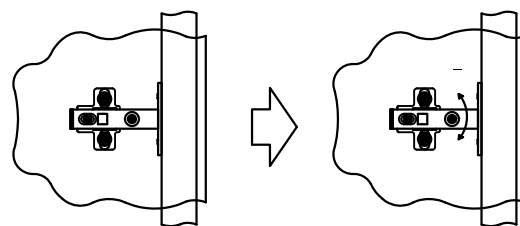

+ = meer ruimte
- = minder ruimte

7A
φ4*16 X12

